

TABLE OF CONTENTS

CHAIN GUIDES FOR ROLLER CHAINS	3
STEEL PROFILES FOR CHAIN GUIDES	8
ULTRATRAC BELT GUIDES	9
J LEGS & SNAP-ONS	10
FULL & HALF ROUNDS.....	12
U-CHANNELS, RIGHT ANGLES, DOG BONE	13
BOARDS, RODS & TUBES	14

TIVAR® PROFILES

Premium Formulations

- TIVAR® ESD
- TIVAR® Oil Filled
- TIVAR® H.O.T.
- TIVAR® 1000
- TIVAR® HPV
- TIVAR® UV

Availability

- TIVAR® profiles are available in many standard shapes, but can also be custom designed. Our engineers and specialists can work with you to create your own design. Contact your inside sales representative for more information.

Key Benefits

- TIVAR® wearstrips are easy to install and offer superior life for conveyor belts, chains and other moving machinery or products
- TIVAR® can reduce noise levels up to 50%
- TIVAR® is 1/8 the weight of steel, but can outwear 3:1 for most conveyor applications.
- TIVAR® is sanitary and self-lubricating

Applications

- Bottling/Packaging
- Transportation
- Chemical Processing
- Food Processing
- Industrial/Heavy Equipment
- Medical/Pharmaceutical
- Water Treatment

CONVEYING COMPONENTS

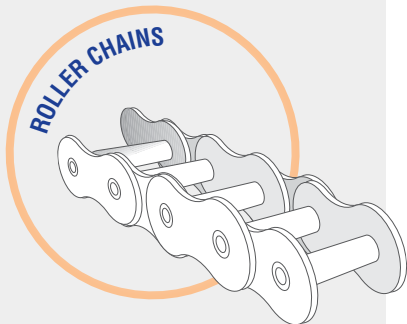

INDUSTRIAL CHAIN GUIDES FOR ROLLER CHAINS

TIVAR® industrial chain guides are available in TIVAR® 1000, which meets guidelines for food handling, including those from FDA, USDA and 3-A Dairy. TIVAR®'s self-lubricating surface minimizes friction and extends chain life.

CHAIN GUIDE STANDARDS

- 10-foot lengths
- Single and double-strand chain
- Natural in color
(Custom colors and triple-strand designs also available)
- Some items stocked, please inquire



TIVAR® CHAIN GUIDE

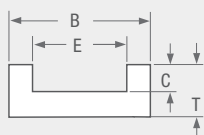

FIG A

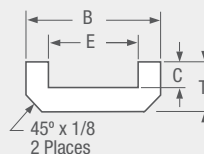
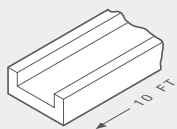

FIG B

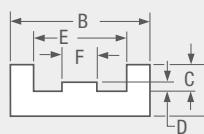
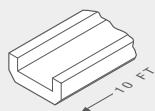

FIG C

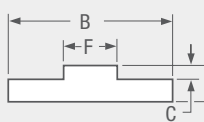
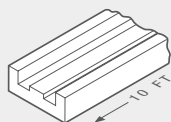
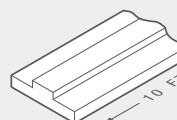

FIG D



CATALOG NO.	FIG	ASA CHAIN NO.	T MIN. (in.)	B (in.)	C (in.)	D (in.)	E (in.)	F (in.)
EUHC1040	A	2040	5/16	1 1/4	1/8	-	7/8	-
EUHC1050	A	2050	3/8	1 1/4	5/32	-	1	-
EUHC1060	A	2060	3/8	1 1/2	3/16	-	1 1/4	-
EUHC1080	A	2080	1/2	2	1/4	-	1 9/16	-
EUHC1100	A	2100	5/8	2 1/4	5/16	-	1 7/8	-
EUHC1120	A	2120	5/8	2 3/4	3/8	-	2 1/4	-
EUHC1003 ₁	A	H78/S188	1 1/4	4 1/4	7/8	-	3 1/2	-
EUHC1004 ₂	A	81X/1578	1	3	5/8	-	2 1/2	-
EUHC0040	B	2040	5/16	1 1/4	1/8	-	7/8	-
EUHC0050	B	2050	3/8	1 1/4	5/32	-	1	-
EUHC0060	B	2060	3/8	1 1/2	3/16	-	1 1/4	-
EUHC0080	B	2080	1/2	2	1/4	-	1 9/16	-
EUHC0100	B	2100	5/8	2 1/4	5/16	-	1 7/8	-
EUHC0120	B	2120	5/8	2 3/4	3/8	-	2 1/4	-

- USDA/FDA/3-A Dairy Compliant
- Quiet: Reduces noise
- For use with plastic or metal chain

CATALOG NO.	FIG	ASA CHAIN NO.	T MIN. (in.)	B (in.)	C (in.)	D (in.)	E (in.)	F (in.)
EUHC2040	C	2040	5/16	1	0.140	0.080	11/16	1/4
EUHC2050	C	2050	3/8	1 1/4	3/16	0.100	13/16	5/16
EUHC2060	C	2060	1/2	1 1/2	0.213	0.115	1 1/8	7/16
EUHC2080	C	2080	1/2	2	1/4	0.130	1 7/16	9/16
EUHC5040	D	2040	5/16	1	0.080	-	-	1/4
EUHC5050	D	2050	5/16	1 1/4	0.100	-	-	5/16
EUHC5060	D	2060	5/16	1 1/4	0.115	-	-	7/16
EUHC5080	D	2080	3/8	1 1/2	0.130	-	-	9/16
EUHC5100	D	2100	1/2	2	0.210	-	-	11/16
EUHC5120	D	2120	1/2	2 1/4	0.260	-	-	15/16

1. Please use EP101
2. Please use EP102

INDUSTRIAL CHAIN GUIDES FOR ROLLER CHAINS



TIVAR® CHAIN GUIDE

CATALOG NO.	FIG	ASA CHAIN NO.	T MIN.(in)	B (in.)	C (in.)	D (in.)	E (in.)	F (in.)
EUHC6040	E	2040	5/16	1	0.080	-	-	1/4
EUHC6050	E	2050	5/16	1 1/4	0.100	-	-	5/16
EUHC6060	E	2060	5/16	1 1/4	0.115	-	-	7/16
EUHC6080	E	2080	3/8	1 1/2	0.130	-	-	9/16
EUHC6100	E	2100	1/2	2	0.210	-	-	11/16
EUHC6120	E	2120	1/2	2 1/4	0.260	-	-	15/16

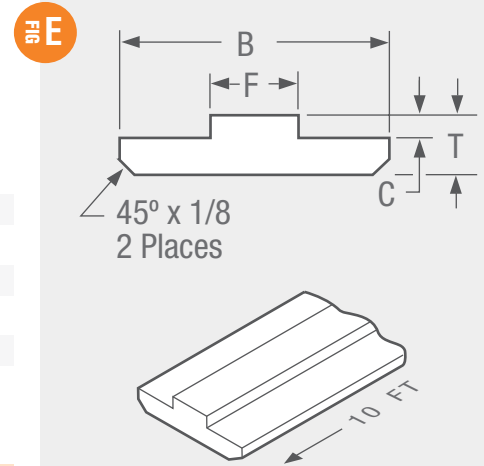

LIMITING PV-VALUES

- Tribological test procedure: Thrust washer testing
- LPV-limits measured on a Thrust Washer rotating against a metal system, speed 0.5 m/s (wear as limit)

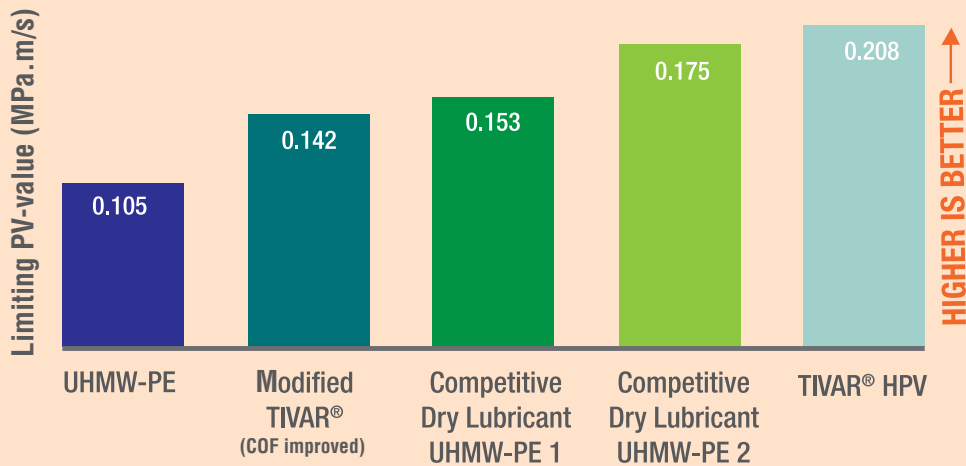

* Data Source: Quadrant Lab Tests

APPLICATION STORY:

Problem: Conveyor company was installing TIVAR® 1000 chain guides to help with wear. The TIVAR® 1000 helped reduce overall wear, but they still had to replace the profiles more frequently than desired.

Solution: Replaced TIVAR® 1000 with TIVAR® HPV for added wear properties under weight loads.

Benefits: Customer saw a 30% decrease in chain wear, improved uptime, and a bonus of 3% less noise in their system.

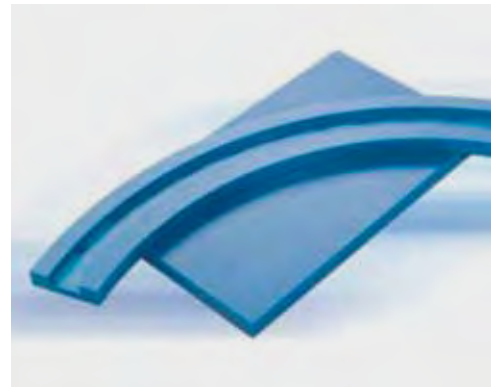

ULTRATRAC CHAIN GUIDES FOR ROLLER CHAINS

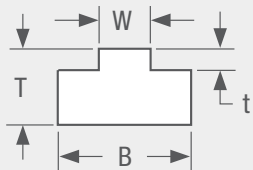

TYPE T

ULTRATRAC CHAIN GUIDES FOR ROLLER CHAINS

- Sanitary: USDA/FDA/3A Dairy Compliant
- Extends chain life
- Minimizes friction
- Quiet: Reduces noise
- Cost effective



TYPE T • ANSI STANDARD ROLLER CHAIN

CATALOG NO.	ANSI CHAIN #	B	T	W	t
EUHU2825	25	.78	.59	.10	.09
EUHU2835	35	.78	.59	.17	.10
EUHU2840	40	.78	.59	.29	.10
EUHU2850	50	.78	.59	.35	.12
EUHU2860	60	1.10	.59	.47	.15
EUHU2880	80	1.34	.71	.60	.18
EUHU2810	100	1.61	1.00	.72	.26
EUHU2812	120	2.01	1.25	.96	.31
EUHU2814	140	2.17	1.50	.96	.36
EUHU2816	160	2.61	1.50	1.21	.42
EUHU2818	180	2.88	1.50	1.35	.47

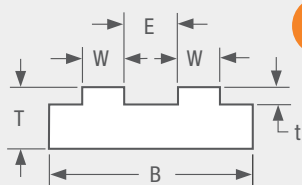

FIG A

TYPE TD

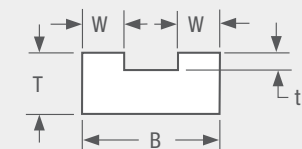

FIG B

TYPE TD • DOUBLE STRAND ANSI STANDARD ROLLER CHAIN

CATALOG NO.	ANSI CHAIN #	B	T	W	t	E	FIG.
EUHU2925	25-2	.78	.59	.10	.09	.15	A
EUHU2935	35-2	.78	.59	.17	.10	.23	A
EUHU2940	40-2	.85	.59	.29	.10	.27	B
EUHU2950	50-2	1.07	.59	.35	.12	.37	B
EUHU2960	60-2	1.34	.59	.47	.15	.40	B
EUHU2980	80-2	1.75	.71	.60	.18	.55	B

Standard lengths of TIVAR® profiles are 120". Standard profile is TIVAR® 1000. (TYPE T & TD)

Also available for triple strand chain. (TYPE TD)

TYPE U • ANSI STANDARD ROLLER CHAIN

CATALOG NO.	ANSI CHAIN #	B	T	T2	T3	D1	H
EUHU3025	25	.78	.59	.09	.13	.12	.27
EUHU3035	35	.78	.59	.15	.22	.16	.39
EUHU3040	40	.78	.59	.18	.26	.21	.51
EUHU3050	50	1.10	.71	.24	.35	.28	.67
EUHU3060	60	1.10	.71	.28	.41	.32	.78
EUHU3080	80	1.50	.79	.30	.47	.43	1.04

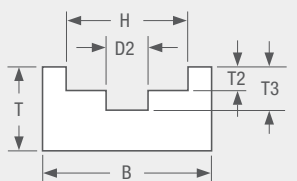

TYPE U

TYPE K • ANSI STANDARD ROLLER CHAIN

CATALOG NO.	ANSI CHAIN #	B	T	W	T2	T3	D1	H
EUHU3125	25	.78	.88	.10	.20	.24	.15	.27
EUHU3135	35	.78	.88	.17	.32	.40	.22	.39
EUHU3140	40	1.10	1.05	.29	.45	.52	.33	.51
EUHU3150	50	1.50	1.43	.35	.55	.61	.42	.67
EUHU3160	60; 60H	1.50	1.85	.47	.76	.88	.49	.78
EUHU3180	80; 80H	1.50	2.45	.60	.96	1.19	.65	1.04

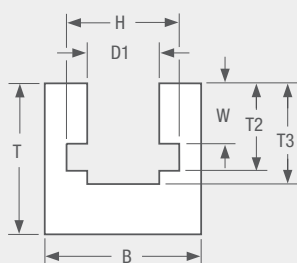

TYPE K

ULTRATRAC CHAIN GUIDES WITH STEEL PROFILES

ULTRATRAC CHAIN GUIDES WITH/WITHOUT STEEL PROFILES

*Please indicate if steel profiles are required

TYPE CF • FLAT PROFILE

CATALOG NO.	METAL PROFILE	T	Tc	B	t
EUHU3201	C3	.59	.79	.78	.40
EUHU3202	C5	.79	1.03	1.10	.56
EUHU3203	C9	.79	1.16	1.50	.45
EUHU3204	C5	.39	.63	1.10	.16

TYPE CF

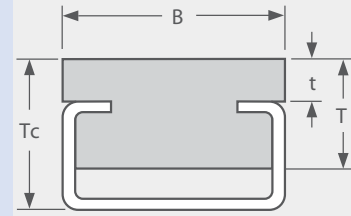

TYPE CT • ANSI STANDARD ROLLER CHAIN

CATALOG NO.	ANSI CHAIN #	METAL PROFILE	T	Tc	B	W	t
EUHU3325	25	C3	.59	.79	.78	.10	.09
EUHU3335	35	C3	.59	.79	.78	.17	.10
EUHU3340	40	C3	.59	.79	.78	.29	.10
EUHU3350	50	C3	.59	.79	.78	.35	.12
EUHU3360	60	C5	.59	.79	1.10	.46	.15
EUHU3380	80	C5	.71	.95	1.34	.60	.18

TYPE CT

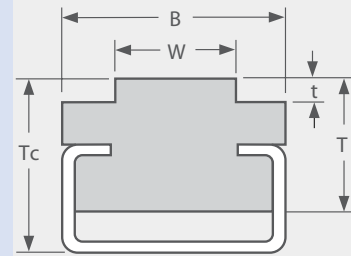

TYPE CU • ANSI STANDARD ROLLER CHAIN

CATALOG NO.	ANSI CHAIN #	METAL PROFILE	T	Tc	B	H	S
EUHU3525	25	C3	.59	.79	.78	.27	.09
EUHU3535	35	C3	.59	.79	.78	.39	.15
EUHU3540	40	C3	.59	.79	.78	.51	.18
EUHU3550	50	C5	.71	.95	1.10	.67	.24
EUHU3560	60	C5	.71	.95	1.10	.78	.28
EUHU3580	80	C9	.79	1.16	1.50	1.04	.30

TYPE CU

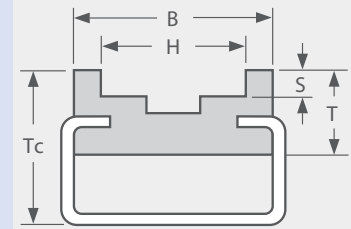

Standard lengths of TIVAR® profile and steel C-Channel are 120". (TYPE CF, CT, CU & CTD)
Also available for triple strand chain. (TYPE CTD)

TYPE CTD • DOUBLE STRAND ANSI STANDARD ROLLER CHAIN

CATALOG NO.	NSI CHAIN #	METAL PROFILE	T	Tc	B	W	t	E	FIG.
EUHU3425	25-2	C3	.59	.79	.78	.10	.09	0.15	A
EUHU3435	35-2	C3	.59	.79	.78	.17	.10	0.23	A
EUHU3440	40-2	C3	.59	.79	.85	.29	.10	-	B
EUHU3450	50-2	C5	.59	.79	1.06	.35	.12	-	B
EUHU3460	60-2	C5	.59	.79	1.34	.47	.15	-	B
EUHU3480	80-2	C9	.71	.95	1.75	.60	.18	-	B

TYPE CTD

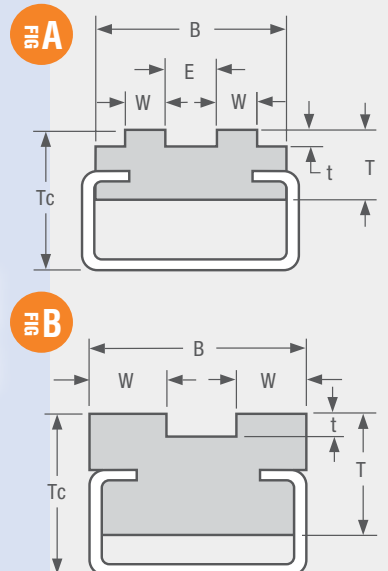

ULTRATRAC CHAIN GUIDES WITH STEEL PROFILES

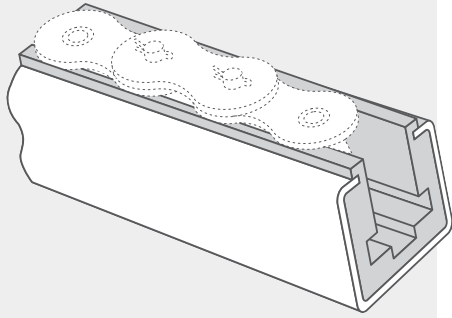

Standard lengths of TIVAR® profile and steel C-Channel are 120". (TYPE CK & CKG)

ULTRATRAC CHAIN GUIDES

*Please indicate if steel profiles are required

TYPE CK • ANSI STANDARD ROLLER CHAIN

CATALOG NO.	ANSI CHAIN #	METAL PROFILE	Tc	B	W	d1
EUHU3625	25	C3	.94	.78	.10	.15
EUHU3635	35	C3	.94	.78	.17	.22
EUHU3640	40	C5	1.13	1.10	.29	.33
EUHU3650	50	C9	1.53	1.50	.35	.42
EUHU3660	60	C9	1.95	1.50	.47	.49
EUHU3680	80	C9	2.55	1.50	.60	.65

TYPE CKG • ANSI STANDARD ROLLER CHAIN

CATALOG NO.	ANSI CHAIN #	METAL PROFILE	Tc	Tc1	B	W	W1	d1
EUHU3725	25	C9	.71		1.50	.10		.15
EUHU3735	35	C10	.94		1.18	.17		.22
EUHU3740	40	C10	.94		1.18	.29		.33
EUHU3750	50	C10	.94		1.18	.35		.42
EUHU3760	60	C10		1.02	1.18		.47	.49
EUHU3761	60	C11	1.58		1.77	.47		.49
EUHU3780	80	C11	1.58		1.77	.60		.65

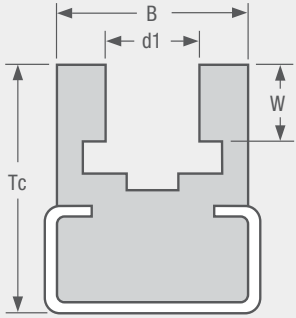

TYPE CK

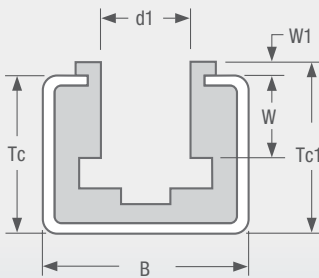

TYPE CKG

APPLICATION STORY:

Problem: Manufacturer used aluminum rails in their system, but they were having problems with release of product touching the rails.

Solution: Replace aluminum with an oil filled formula that Quadrant custom created for them.

Benefits: Customer got the release and durability that they were looking for, with the benefit of better wear.



ULTRATRAC BELT GUIDES

ULTRATRAC BELT GUIDES

*Please indicate if steel profiles are required

TIVAR® belt guides are an excellent low-friction surface for rubber and urethane, belts or cables. TIVAR® belt guides are also available in metric sizes for round and V-belts. Belt guides are available with or without steel profiles.

TYPE V • TIVAR® V-BELT GUIDES

CATALOG NO.	BELT	T	B	D	H
EUHU2208	M	.38	.75	.25	.13
EUHU2210	Z	.38	.75	.28	.19
EUHU2213	A	.50	.75	.38	.25
EUHU2217	B	.63	1.25	.47	.31
EUHU2220	-	.75	1.25	.53	.38
EUHU2222	C	.75	1.38	.56	.44
EUHU2225	-	1.00	1.50	.66	.50

TYPE CV • V-BELT GUIDE: FOR USE WITH STEEL PROFILES

CATALOG NO.	BELT	METAL PROFILE	T	B	C	Tc	D	H
EUHU1425	M	C3	.59	.78	.19	.79	.25	.13
EUHU1428	Z	C3	.59	.78	.19	.79	.28	.19
EUHU1438	A	C3	.59	.78	.19	.79	.38	.25
EUHU1447	B	C5	.81	1.10	.22	1.04	.47	.31
EUHU1453	-	C5	.81	1.10	.22	1.04	.53	.38
EUHU1456	C	C5	.81	1.10	.22	1.04	.56	.44
EUHU1466	-	C9	1.00	1.50	.33	1.38	.66	.50

TYPE R • TIVAR® ROUND BELT GUIDES

CATALOG NO.	BELT	T	B	D	H
EUHU2005	3/16	.38	.75	.25	.13
EUHU2006	1/4	.38	.75	.31	.16
EUHU2008	5/16	.50	.75	.38	.19
EUHU2010	3/8	.63	1.00	.44	.22
EUHU2012	1/2	.75	1.25	.56	.28
EUHU2015	5/8	1.00	1.25	.69	.35
EUHU2018	3/4	1.00	1.50	.81	.41

TYPE CR • ROUND BELT GUIDE: FOR USE WITH STEEL PROFILES

CATALOG NO.	BELT	METAL PROFILE	T	B	C	Tc	D	H
EUHU1125	3/16	C3	.59	.78	.19	.79	.25	.13
EUHU1131	1/4	C3	.59	.78	.19	.79	.31	.16
EUHU1138	5/16	C3	.59	.78	.19	.79	.38	.19
EUHU1144	3/8	C5	.59	1.10	.27	.79	.44	.22
EUHU1156	1/2	C5	.59	1.10	.22	.79	.56	.28
EUHU1169	5/8	C5	.75	1.10	.22	.94	.69	.35
EUHU1181	3/4	C5	1.00	1.10	.33	1.25	.81	.41

TYPE V

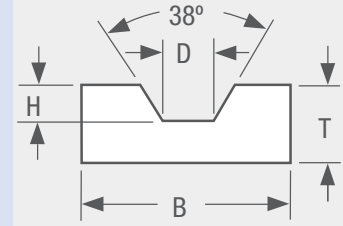

TYPE CV

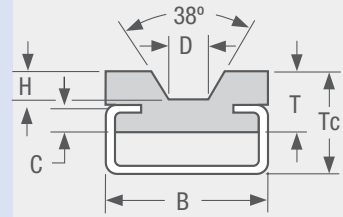

Standard lengths of TIVAR® 1000 profiles are 120".
Other materials available upon request. (TYPE V & R)

Also available with stainless steel C channel
(galvanized steel or stainless steel) (TYPE CV
& CR)

TYPE R

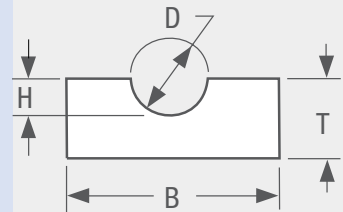

TYPE CR

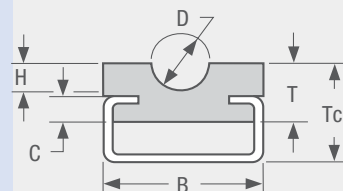

ULTRATRAC CHAIN GUIDES WITH STEEL PROFILES

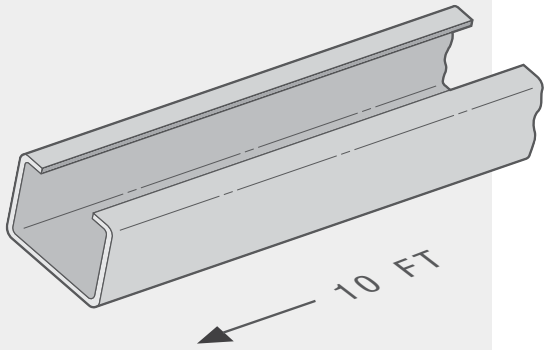

10 FT

10 ft. lengths (GALVANIZED STEEL C-PROFILE & 304 STAINLESS STEEL C-PROFILE)

ULTRATRAC STEEL PROFILES

Ultratrac Steel profiles can be sold Individually or as assemblies with TIVAR® belt guide inserts to save you time and money.

Right for your environment. UltraTrac profiles are available in both stainless steel (for food handling) and galvanized steel.

Easy, economical mounting. Simply screw or weld UltraTrac profiles into place.

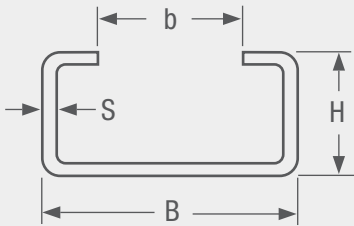

CHANNEL #
C3, C5, C9

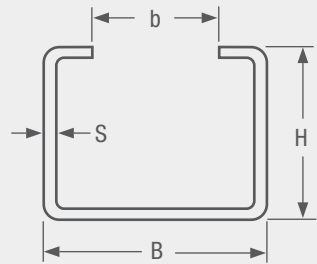

CHANNEL #
C10, C11

GALVANIZED STEEL C-PROFILE

PROFILE NO.	B	b	H	S
C3	.780	.390	.390	.060
C5	1.100	.550	.470	.075
C9	1.500	.870	.710	.100
C10	1.180	.790	.940	.060
C11	1.772	1.22	1.575	.079

304 STAINLESS STEEL C-PROFILE

PROFILE NO.	B	b	H	S
C3	.780	.390	.390	.060
C5	1.100	.550	.470	.075
C9	1.500	.870	.710	.100
C10	1.180	.790	.940	.060
C11	1.772	1.22	1.575	.079

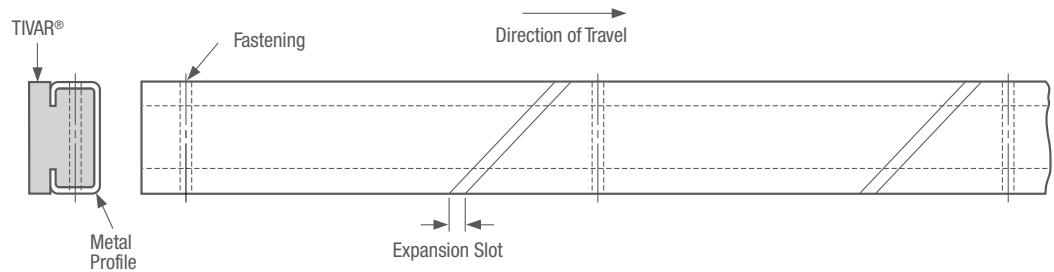

TIP

MOUNTING: Remember the effects of heat when you plan for assemblies of steel and plastic materials. The assembly suggested above accommodates the relatively large linear expansion coefficient of plastic materials. As a rule, the expansion for TIVAR® = .0001 inches / inch / °F. In cases of large temperature fluctuations, we recommend using short slide rails to minimize the width of slots. Slide rails should be fastened to the C-channel to prevent displacement in the direction of travel as illustrated above.

GUIDE RAILS AND WEARSTRIPS

TIVAR® GUIDE RAILS AND WEARSTRIPS

Bold lengths IN STOCK,
Other lengths available upon request

Excellent for:

- Modular belts
- Steel grate bakery chains
- Flat top conveyor chains

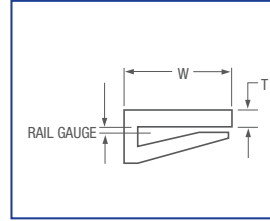
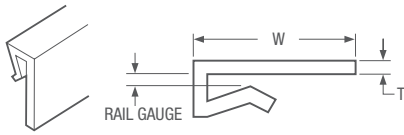

EPP861

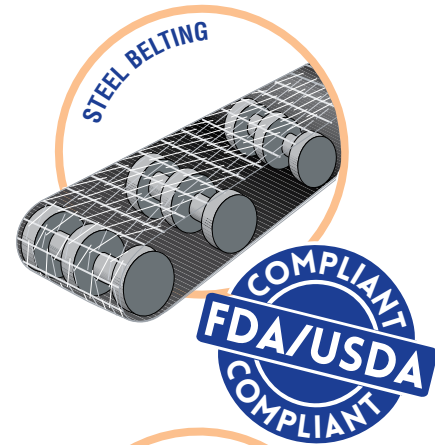

EXTRUDED SNAP-ON WEAR STRIPS (J-LEG)

Bold lengths IN STOCK,
Other lengths available upon request

CATALOG NO.	T	W	STOCK LENGTHS (FT.)	CATALOG NO.	T	W	STOCK LENGTHS (FT.)
EPP601	3/16	3/4	Non-Stock	EPP622	1/8	1 1/2	10' 20'
EPP602	3/16	1	10' 20' 100'	EPP623	1/8	2	10' 20'
EPP636	3/16	1 1/2	10' 20'	EPP625	1/4	1	10' 20'
EPP603	3/16	2	10' 20'	EPP626	1/4	2	10' 20'
EPP604	3/16	2 1/2	Non-Stock	EPP627	1/4	2 7/8	Non-Stock
EPP605	3/16	2 7/8	10' 20'	EPP628	1/4	3	10' 20'
EPP606	3/16	3	10' 20'	EPP634	1/8	15/16	Non-Stock
EPP620	1/8	3/4	10' 20'	EPP861	1/8	3/4	Non-Stock
EPP621	1/8	1	10' 20'				

Fits 12 gauge rail size



BAR SNAP-ONS

Bold lengths IN STOCK,
Other lengths available upon request

CATALOG NO.	STOCK LENGTHS (ft.)	CATALOG NO.	STOCK LENGTHS (ft.)
EPP801	10' 100' 250' 500' Coils	EPP805	Non-Stock
EPP802	10' 100'	EPP806	10' 100' Coils
EPP803	10' 100' 250' 500' Coils	EPP850	Non-Stock
EPP804	10' 100' 250' Coils	EPP851	10' 100' 250' Coils

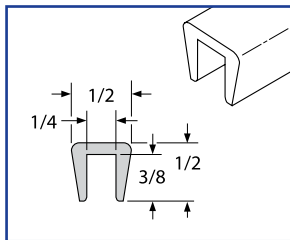
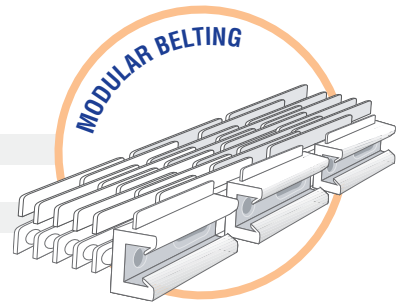

EPP801 • 1/4"

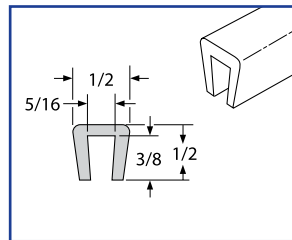

EPP802 • 5/16"

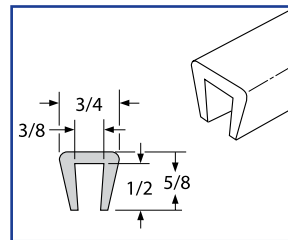

EPP803 • 3/8"

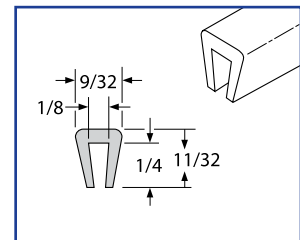

EPP804 • 1/8"

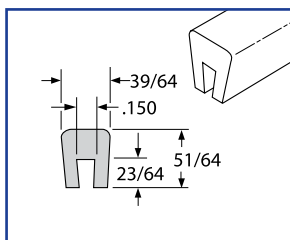

EPP805 • 13/64"

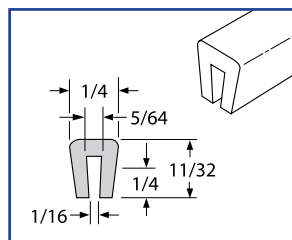

EPP806 • 5/64"

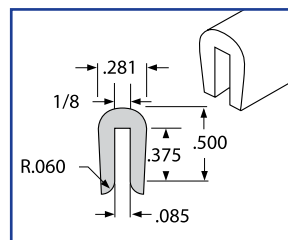

EPP850 • 1/8"

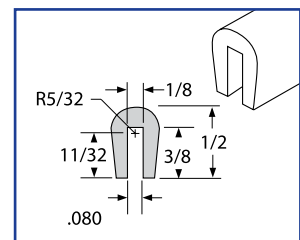

EPP851 • 1/8"

GUIDE RAILS AND WEARSTRIPS

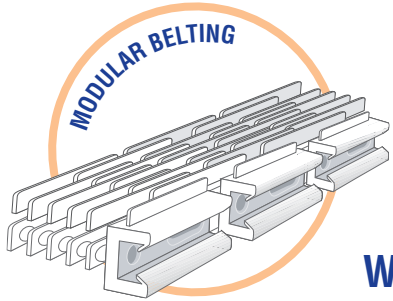

MODULAR BELTING

WEARMAX

CATALOG NO. STOCK LENGTHS (ft.)

EPP824	Non-Stock
EPP825	100'
EPP834	10'

TIVAR® WEARMAX, GUIDE RAILS & C-CHANNELS

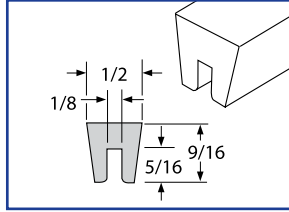

EPP824 • 1/8"

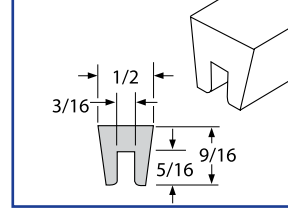

EPP825 • 3/16"

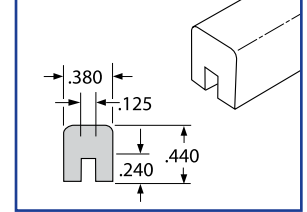

EPP834 • 1/8"

GUIDE RAIL SNAP-ON

CATALOG NO. STOCK LENGTHS (ft.)

EPP702	10' 20'
EPP703	10' 20'
EPP704	10' 20'
EPP705	8' 10' 20'
EPP707	10' 20'
EPP708	10'

CATALOG NO. STOCK LENGTHS (ft.)

EPP903	10' 20'
EPP706	10'
EPP904	10' 20'
EPP951	10' 50'

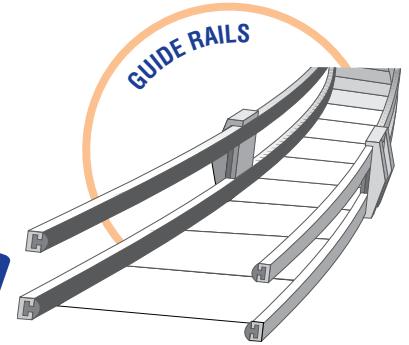

GUIDE RAILS

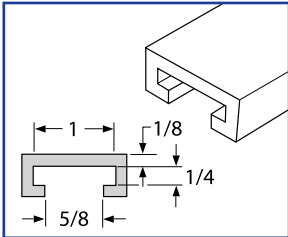

EPP702 • 1/4" x 1"

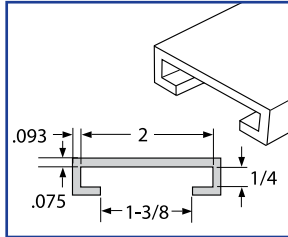

EPP703 • 1/4" x 2"

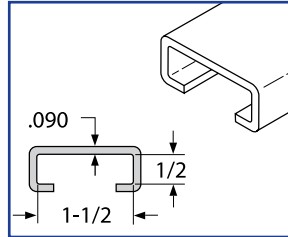

EPP704 1/2" x 1 1/2"

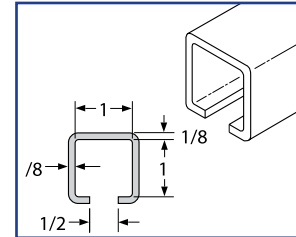

EPP705 • 1" x 1"

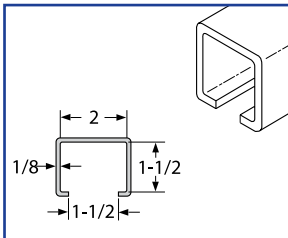

EPP707 • 1 1/2" x 2"

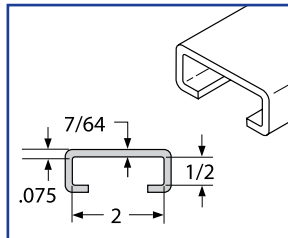

EPP708 • 1/2" x 2"

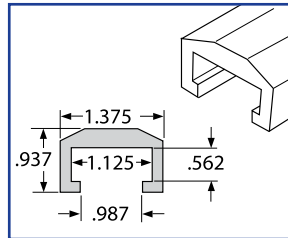

EPP706 • .562" x 1.125"

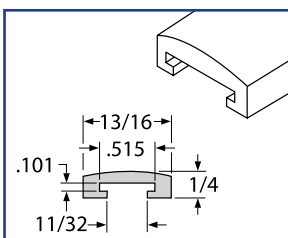

EPP903 • .101" x .515"

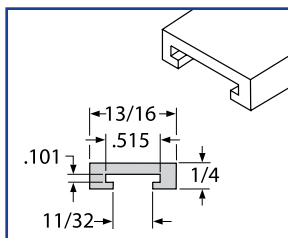

EPP904 • .101" x 13/16"

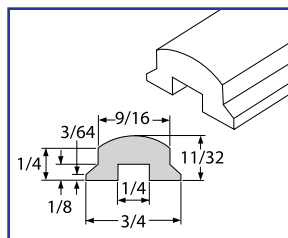

EPP951 • .1/8" x 1/4"

Standard stock is TIVAR® 1000 natural.
Also available in other premium
TIVAR® formulations.

GUIDE RAILS AND WEARSTRIPS

TIVAR® FULL & HALF ROUNDS

Bold lengths IN STOCK,
Other lengths available upon request

FULL ROUND

CATALOG NO.	STOCK LENGTHS (ft.)
EPP350	10'
EPP351	10' 100' 250' Coils
EPP352	10' 100' Coils

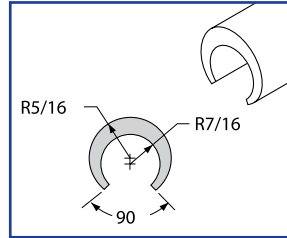

EPP350 • 5/8"

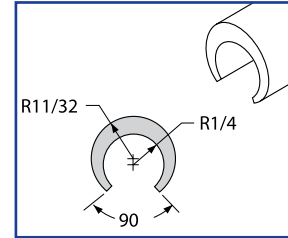

EPP351 • 1/2"

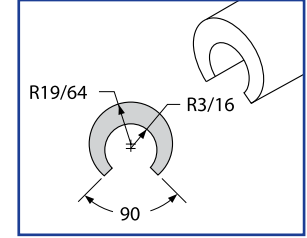

EPP352 • 3/8"

HALF ROUND

CATALOG NO.	STOCK LENGTHS (ft.)
EPP301	10' 100' 250'
EPP302	10' 100' 250'
EPP303	10' 100'

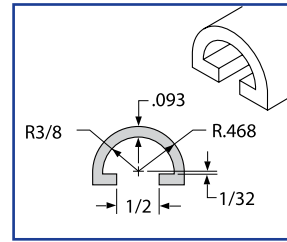

EPP301 • 3/4"

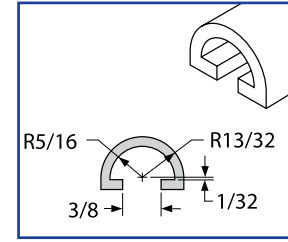

EPP302 • 5/8"

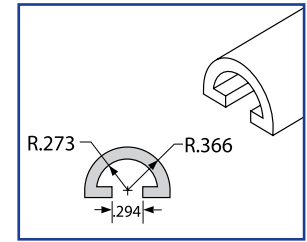

EPP303 • 1/2"

Standard stock lengths available in TIVAR®
1000. Other materials available upon request.

HALF ROUND WITH FLAT

CATALOG NO.	STOCK LENGTHS (FT.)
EPP304	10'

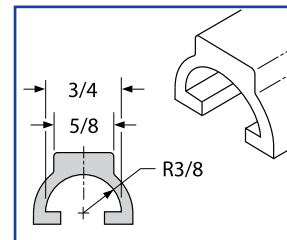

EPP304 • 3/4" F



GUIDE RAILS AND WEARSTRIPS

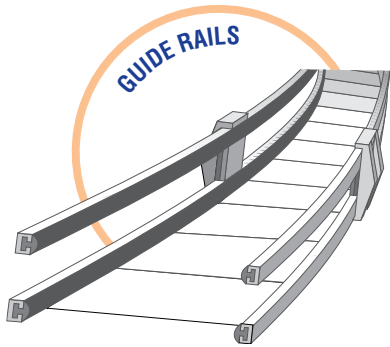

U-CHANNELS, RIGHT ANGLES & DOG BONES

Bold lengths IN STOCK,
Other lengths available upon request

U-CHANNELS

CATALOG NO.	A (in.)	B (in.)	C (in.)	D (in.)	STOCK LENGTHS (ft.)
EP101	7/8	1 1/4	3 1/2	4 1/4	8' 10' 20'
EP102	5/8	1	2 1/2	3	8' 10' 20'
EP103	5/8	1	2	2 1/2	10'
EP104	5/8	1	1 1/2	2	8' 10'
EP105	1/2	7/8	1	1 1/2	41" 8' 10'
EP106	3/8	3/4	1/2	1	8' 10'
EP111	5/8	1	2 1/4	3	10'
EPP112	0.605	0.730	1	1 1/4	8' 10'

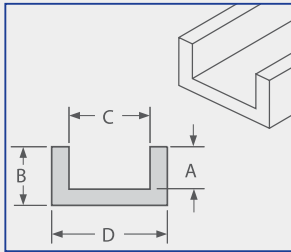

U CHANNELS

RIGHT ANGLES

CATALOG NO.	A (in.)	R1 (in.)	B (in.)	R2 (in.)	C (in.)	STOCK LENGTHS (FT.)
EP201	1/4	.100	1 1/2	.125	1 1/2	8' 10'
EP202	1/4	.040	2	.156	2	8' 10'
EP203	1/2	.094	3	.250	3	8' 10'
EP208	1/2	-	3 1/2	.250	3 1/2	8' 10'
EP210	1/4	1/16	5/8	1/8	1 1/2	8' 10'
EP220	1/8	.093	1	.140	1	Non-Stock
EP221	1/8	.093	1 1/2	.140	1 1/2	Non-Stock
EP222	1/8	.093	2	.140	2	Non-Stock
EP211	1/2	.094	2	.125	2	Non-Stock
EP212	1/2	.094	1.5	.125	1.5	Non-Stock

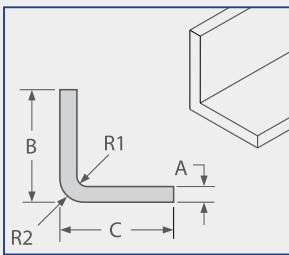

RIGHT ANGLES

DOG BONE WEARSTRIP

CATALOG NO.	STOCK LENGTHS (FT.)
EP501	10'

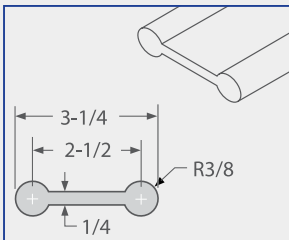

DOG BONE WEARSTRIP
EP501 • 3/4" x 3 1/4"

TIVAR® BOARD, ROD & TUBE

Many TIVAR® extruded rods and boards are sized to allow for machining to a nominal size.



EXCELLENT FOR:

- Bearings and bushings
- Rollers
- Gears
- Cams and cam guide parts
- Timing and feed screws

**TIVAR® EXTRUDED TAPE & BOARD
(NATURAL WHITE)**

PART NO.	THICKNESS (in.)	WIDTH (in.)
EP3005	1/4	2
EP3006	1/4	3
EP3007	1/4	4
EP3010	1/4	7
EP4003	3/8	1
EP4005	3/8	2-5/8
EP4006	3/8	3
EP5007	1/2	4
EB5015	1/2	12
EB7008	1	5
EB7017	1	14
EB7101	1 1/8	2 5/8
EB7102	1 1/8	3 1/4
EB7103	1 1/8	4 1/8
EB7201	1 1/4	2 1/4
EB7219	1 1/4	16
EB7511	1 1/2	8
EB7513	1 1/2	10
EB7517	1 1/2	14
EB8011	2	8
EB8013	2	10
EB8017	2	14
EB8529	2-1/2	26
EB8020	2	18
EB7013	1	10

EXTRUDED ROD

PART NO.	DIAMETER (in.)
ER50	.250
ER60	.375
ER69	.500
ER70	.625
ER71	.750
ER73	1.000
ER74	1.250
ER741	1.375
ER75	1.500
ER76	1.750
ER77	2.000
ER78	2.250
ER79	2.500
ER80	2.750
ER81	3.000
ER82	3.250
ER83	3.500
ER84	3.750
ER85	4.000
ER86	4.250
ER87	4.500
ER88	5.000
ER89	5.500
ER90	6.000
ER91	6.500
ER92	7.000
ER94	8.000
ER96	9.000
ER98	10.000

EXTRUDED TUBING

PART NO.	OD (in.) x ID (in.)
ET080	.875 x .250
ET085	.875 x .375
ET100	1.000 x .500
ET101	1.000 x .750
ET102	1.000 x .625
ET103	.750 x .375
ET111*	1.000 x .563
ET124	1.250 x .750
ET125	1.250 x .625
ET126*	1.250 x .563
ET127	1.250 x 1.000
ET130	1.375 x .625
ET131*	1.375 x .750
ET132	1.375 x 1.000
ET151	1.500 x .500
ET152	1.500 x 1.000
ET154	1.500 x 1.125
ET160	1.625 x 1.250
ET180	1.875 x 1.125
ET181	1.875 x 1.250
ET200	2.000 x 1.000
ET201	2.000 x 1.500
ET202	2.000 x 1.250
ET203	2.000 x 1.750
ET204*	2.000 x 1.375
ET210	2.250 x 1.750
ET202	2.250 x 1.875
ET230	2.375 x 1.750
ET251	2.500 x 1.500
ET252	2.500 x 2.000
ET253	2.500 x 1.000
ET260	2.625 x 2.250
ET270	2.750 x 2.000
ET300	3.000 x 2.000
ET301	3.000 x 2.500
ET310	3.125 x 2.750
ET350	3.500 x 2.500
ET351	3.500 x 3.000
ET400	4.000 x 3.000
ET401	4.000 x 3.500
ET451	4.500 x 4.000
ET500	5.000 x 4.000
ET501	5.000 x 4.500
ET549*	5.500 x 4.375
ET551	5.500 x 4.750
ET625	6.250 x 5.750
ET860	8.625 x 7.875
ET950*	9.500 x 8.250

EXTRUDED RODS AND TUBES AVAILABLE IN:

- TIVAR® 1000 natural and premium formulations
- Color matched in 14 standard colors for timing and feed screws
- All rods stocked in TIVAR® 1000 Natural

Coils are available in all 1/4" board sizes.
Other sizes up to 40 ft. lengths. Minimums may apply
Board items are not stocked

*Non-Stock. Minimums may apply.